

Article number: 203160M16150B2VK

Description: E+G levelling foot
GN 31-60-M16-150-B2-VK

Note: VK With nut, External hexagon at the top, Wrench flat at the bottom

Measures

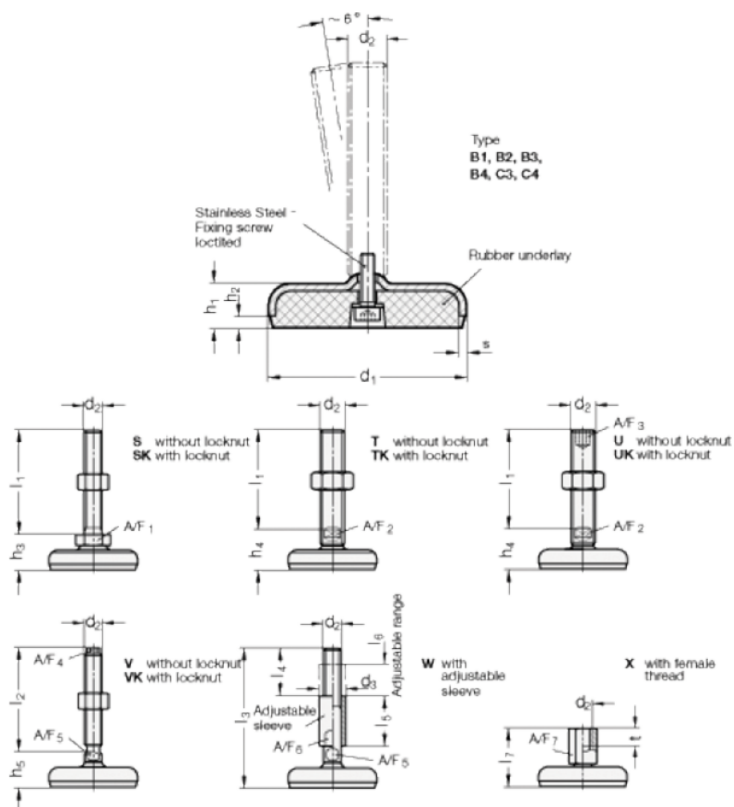

A/F4 = 10

s = 3

A/F5 = 12

d1 = 60

d2 = 16

h1 = 16

h2 = 4

h5 +4.0/0 = 27

l2 = 150